

THE SOVEREIGN OPERATING SYSTEM

PALANTIR'S RISE TO HEGEMONY

A Strategic Analysis of Palantir Technologies (NYSE: PLTR) in the Age of Agentic AI

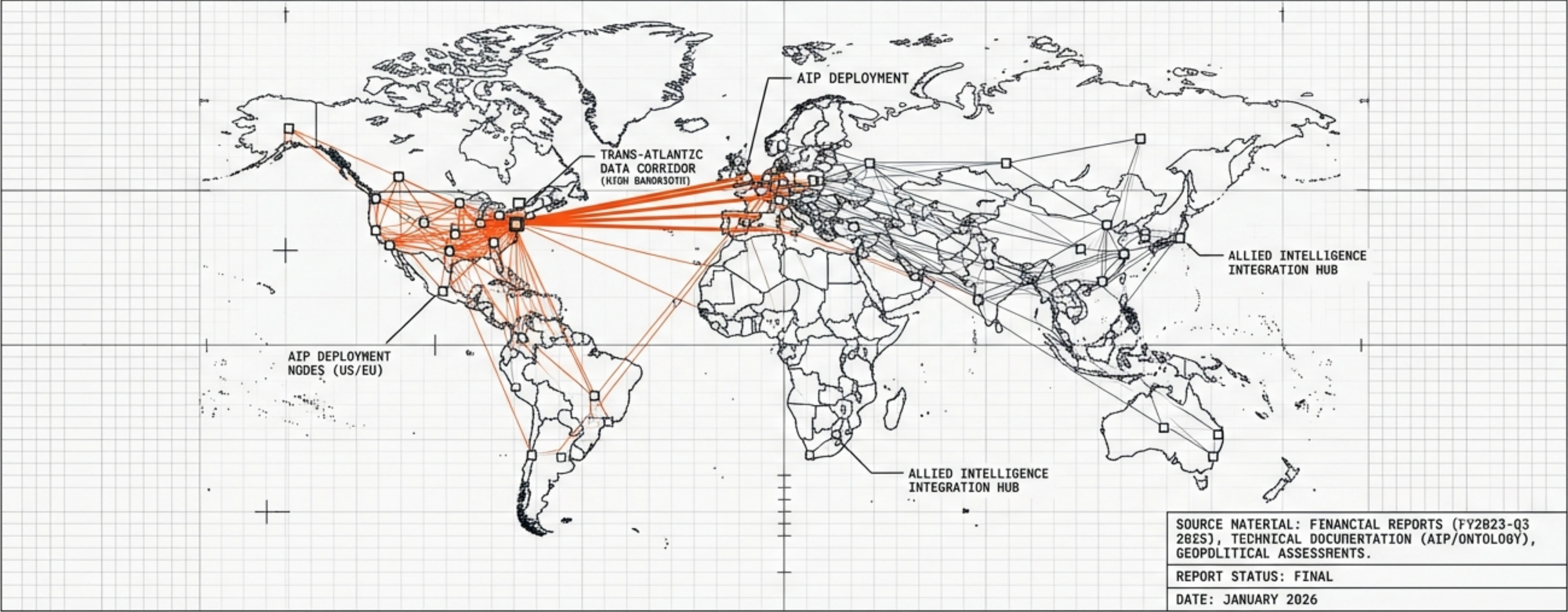

EXECUTIVE SUMMARY: THE 2000% JOURNEY

From “Frankenstein Monster” to S&P 500 Heavyweight



THE SURGE

Stock **+500%** in 12 months.

Institutional ownership jumped from 45% to 53% following S&P 500 inclusion.

THE PIVOT

Shifted from government consultancy to commercial software giant.

US Commercial Revenue growth accelerated to **121% YoY**.

THE CATALYST

AIP & Bootcamps.

Compressed sales cycles from 6 months to 5 days, finding Product-Market Fit 2.0.

THE STATUS

The Operating System for the Modern State.

Rule of 40 Score: **114%**.

THE REBELS WON: A COUNTER-CONSENSUS ORIGIN

THE ORIGIN (2003)

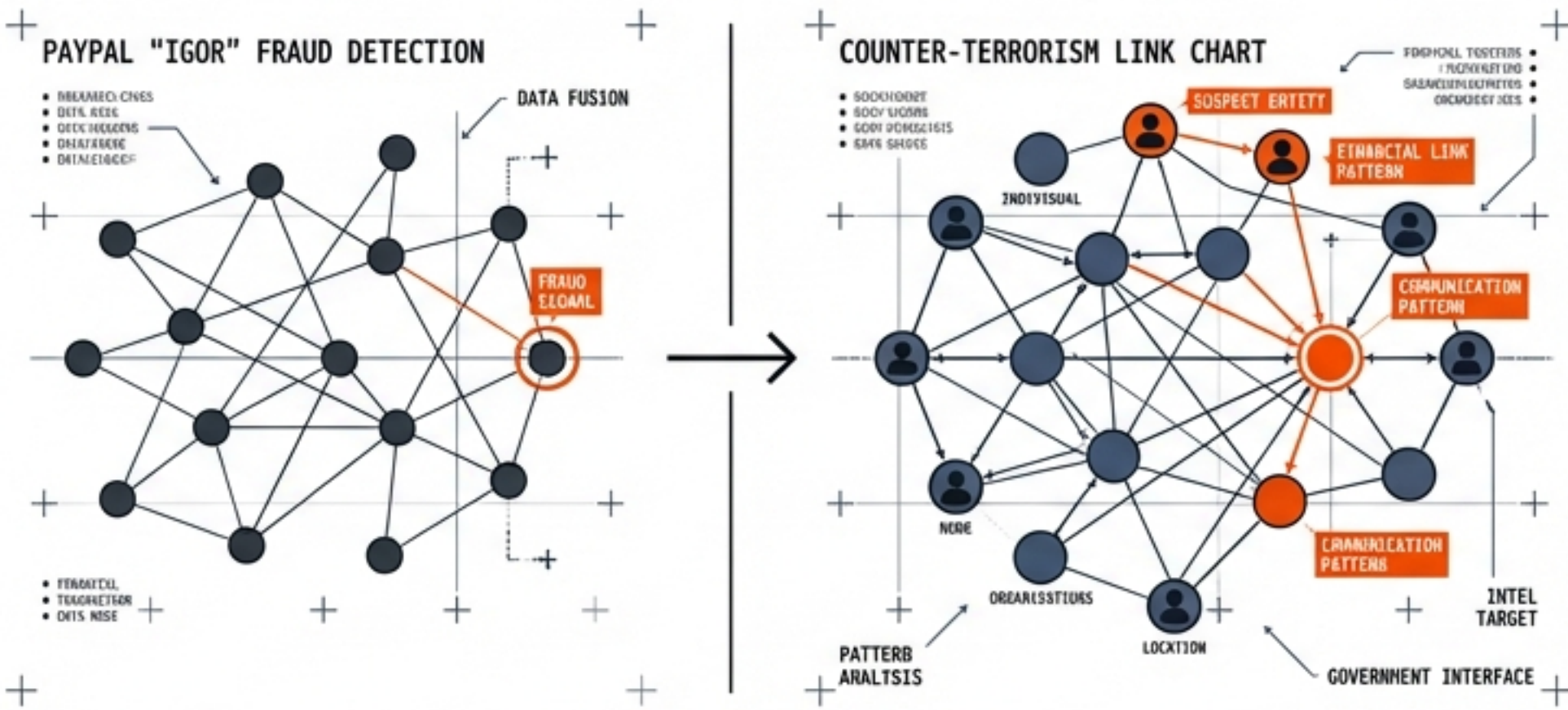

FOUNDERS: Peter Thiel, Alex Karp, Stephen Cohen, Joe Lonsdale, Nathan Gettings.

MISSION: Adapt PayPal's "Igor" fraud detection to hunt terrorists post-9/11.

BACKING: In-Q-Tel (CIA Venture Arm). Rejected by Silicon Valley VCs for being "government software".

THE ETHOS

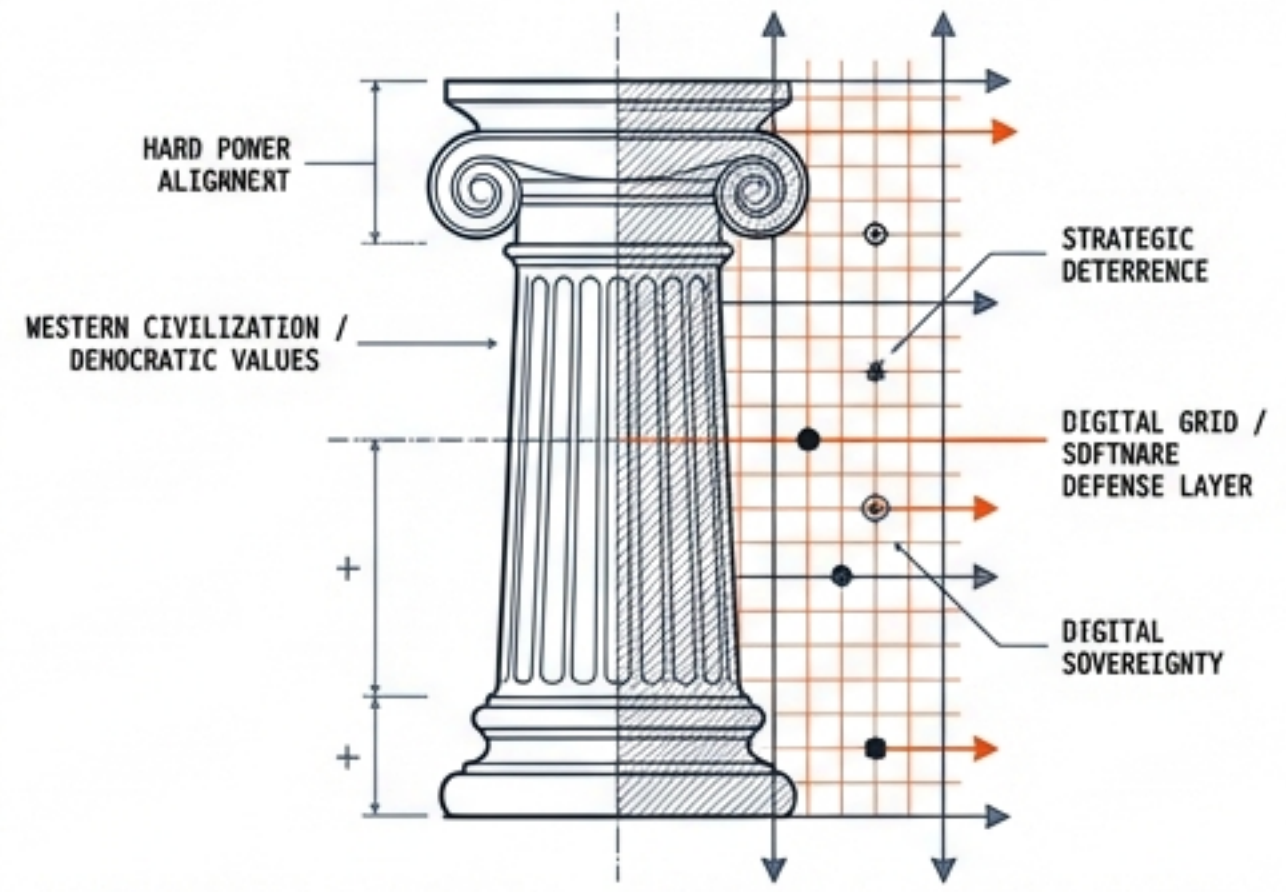

HARD POWER: Rejection of neutrality. Explicit alignment with **US/Western Defense interests**.

PHILOSOPHY: Software as the primary defense of democracy. Rejection of "Data Monopolies" (Google/Facebook) model.

"THE REBELS WON... THE FUTURE BELONGS TO US." — ALEX KARP

THE PRODUCT ECOSYSTEM: AN INTEGRATED STACK

An Operating System, Not a Data Warehouse

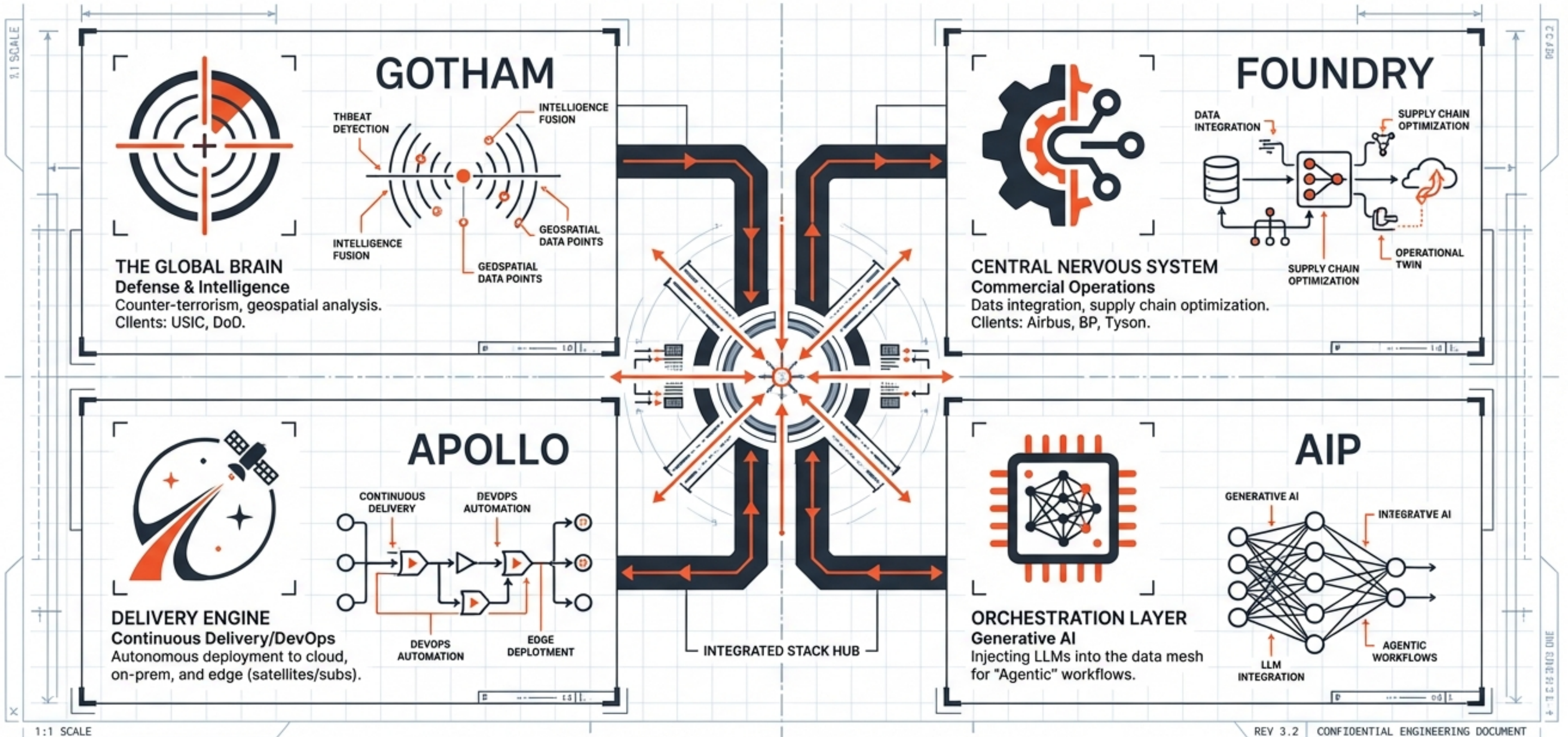

THE TECHNICAL MOAT: THE ONTOLOGY

Why Palantir works when ChatGPT hallucinates.

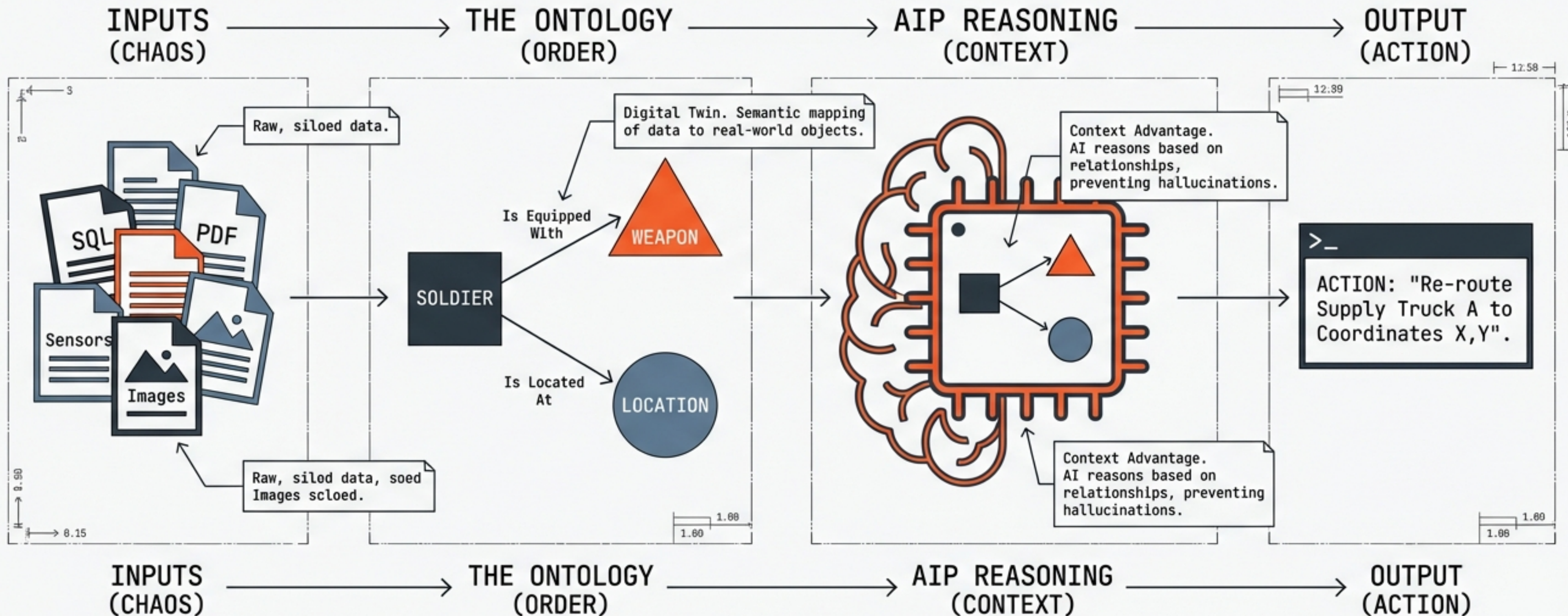

THE CATALYST: AIP & THE BOOTCAMP REVOLUTION

THE INNOVATION

+121%

US Commercial Revenue Growth
(Q3 2025 YoY)

+45% Customer Count

AIP launched in 2023. Allows enterprises to deploy Agents that act, not just chat.

THE SALES HACK

Before and After

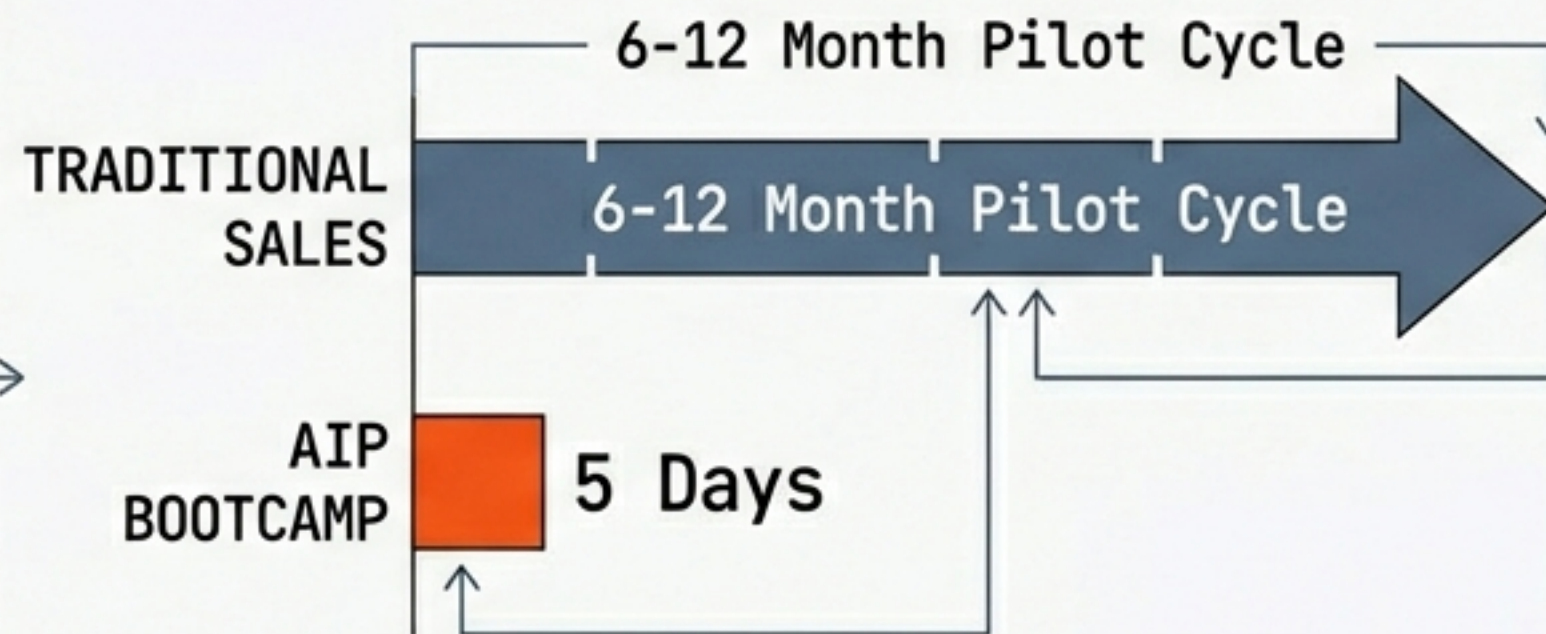

From months of piloting to 5-day 'Hands-on-Keyboard' workshops. Customers build production workflows on their own data.

"The difference is not the model. The difference is context." — Sainath Palla on AIP

DEFENSE DOMINANCE: HARD POWER DIGITIZED

US ARMY ENTERPRISE AGREEMENT



10-Year Contract.
\$10B Ceiling.

Consolidates 75 separate contracts into one framework.

Default data layer for the Army.

TITAN (Tactical Intelligence Targeting Access Node)

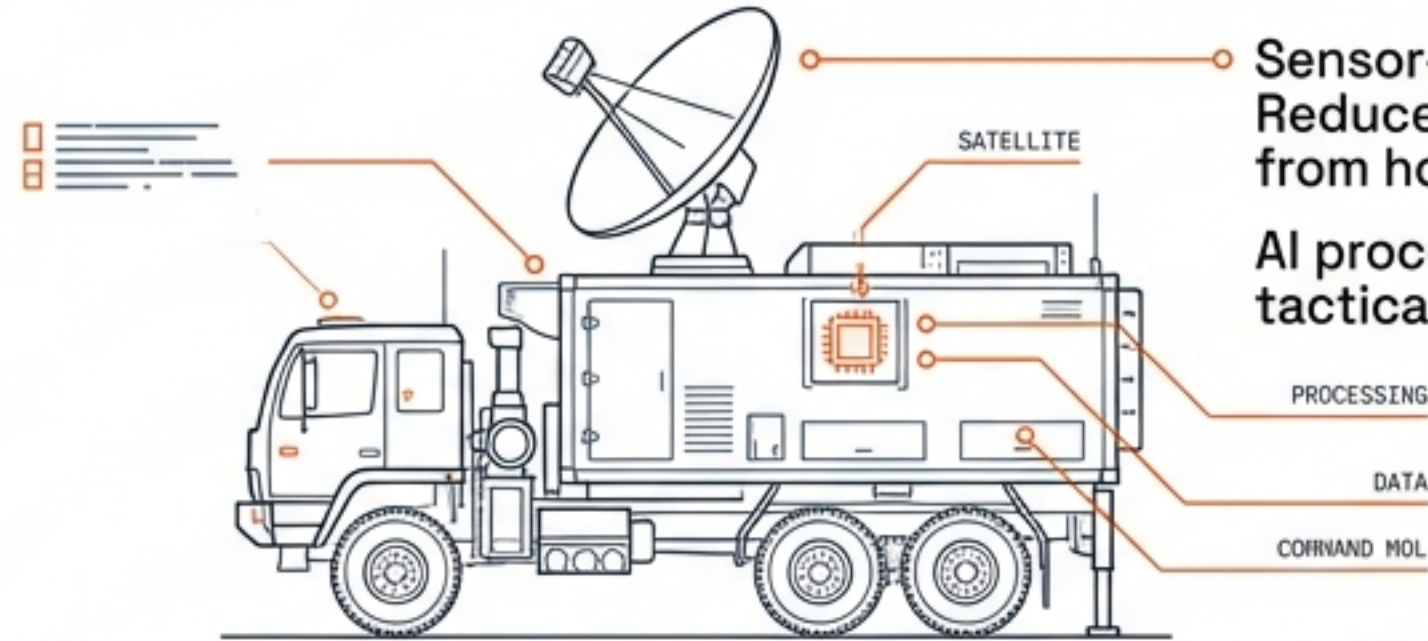

Sensor-to-Shooter.
Reduces targeting time from hours to seconds.

AI processing at the tactical edge.

PROJECT MAVEN & SHIP OS



Maven: \$795M for DoD theater-wide command and control.

ShipOS: \$448M Navy initiative optimizing nuclear submarine production.

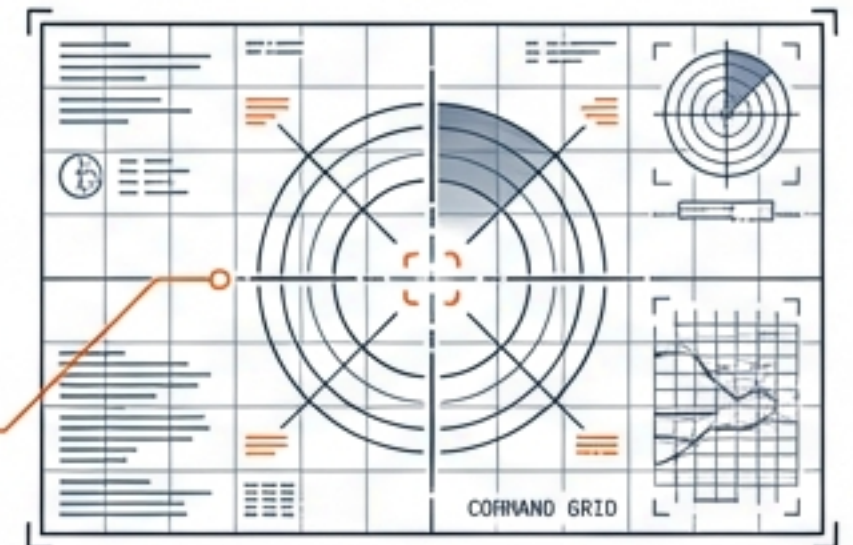

THE EDGE ADVANTAGE: CLOUD TO CONSTELLATION

Infrastructure Agnosticism & MetaConstellation

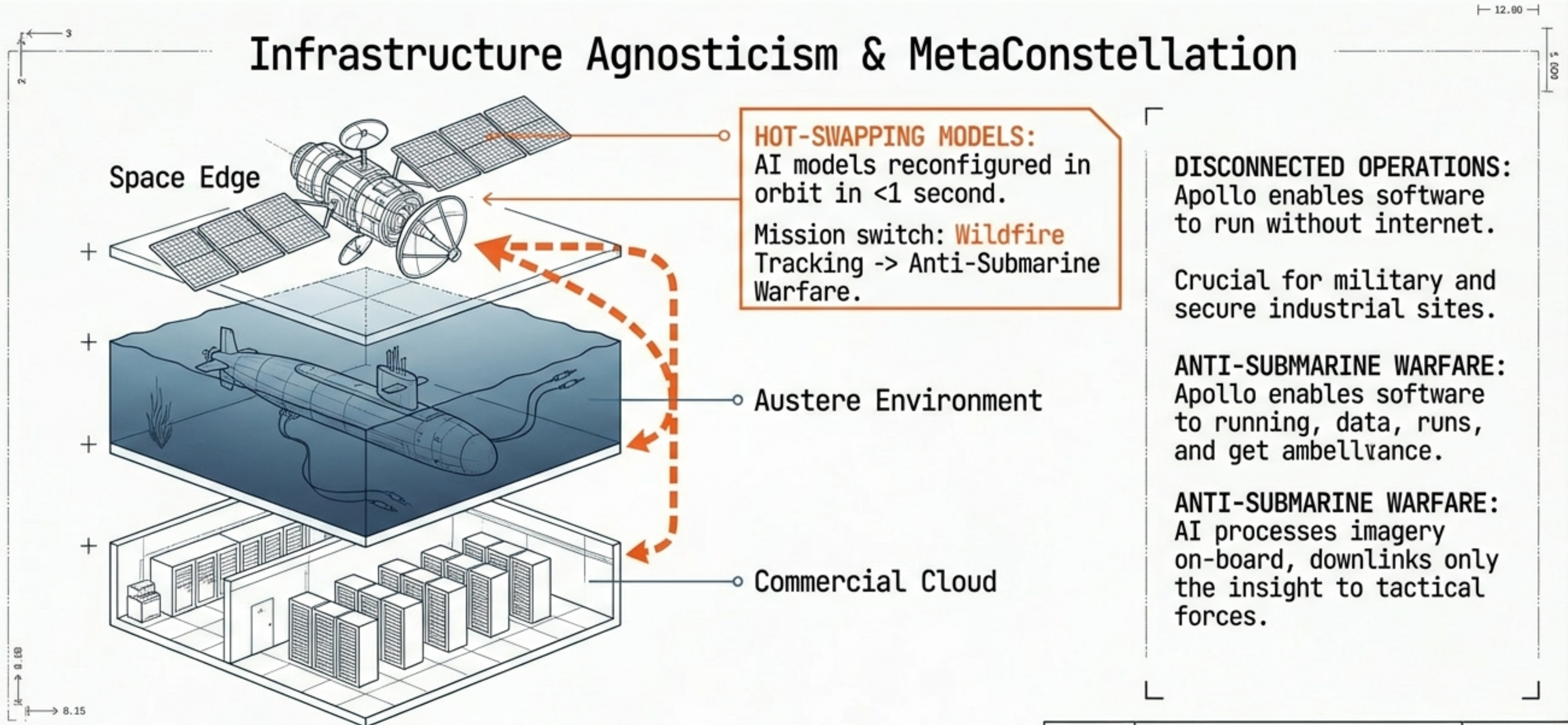

BEYOND THE PENTAGON: INDUSTRIALIZING AI

AIRBUS (SKYWISE)

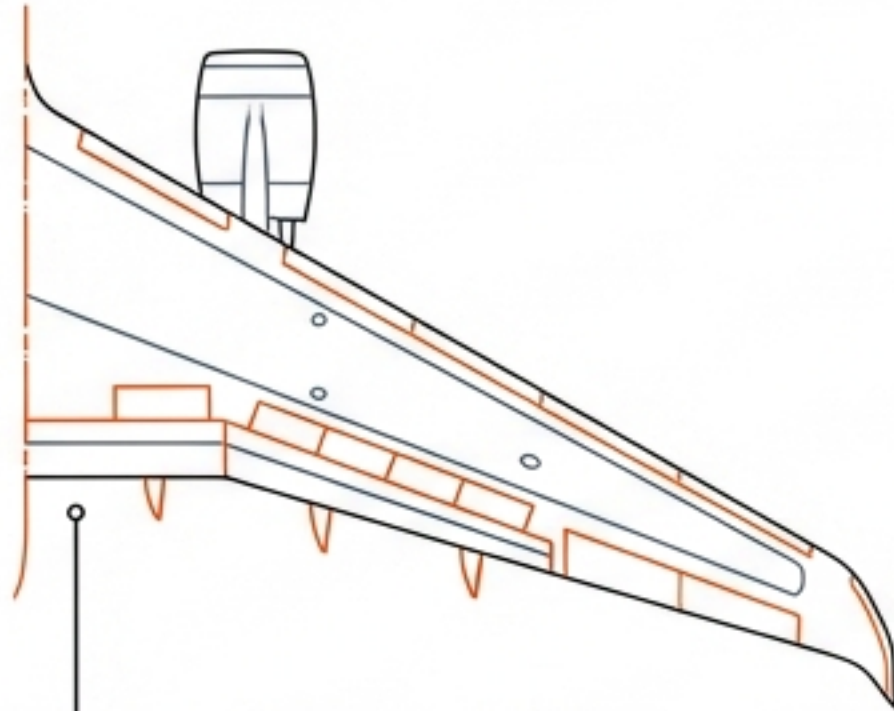

Accelerated A350 production by **33%**.
Manages **petabytes** of maintenance data.

BP (ENERGY)

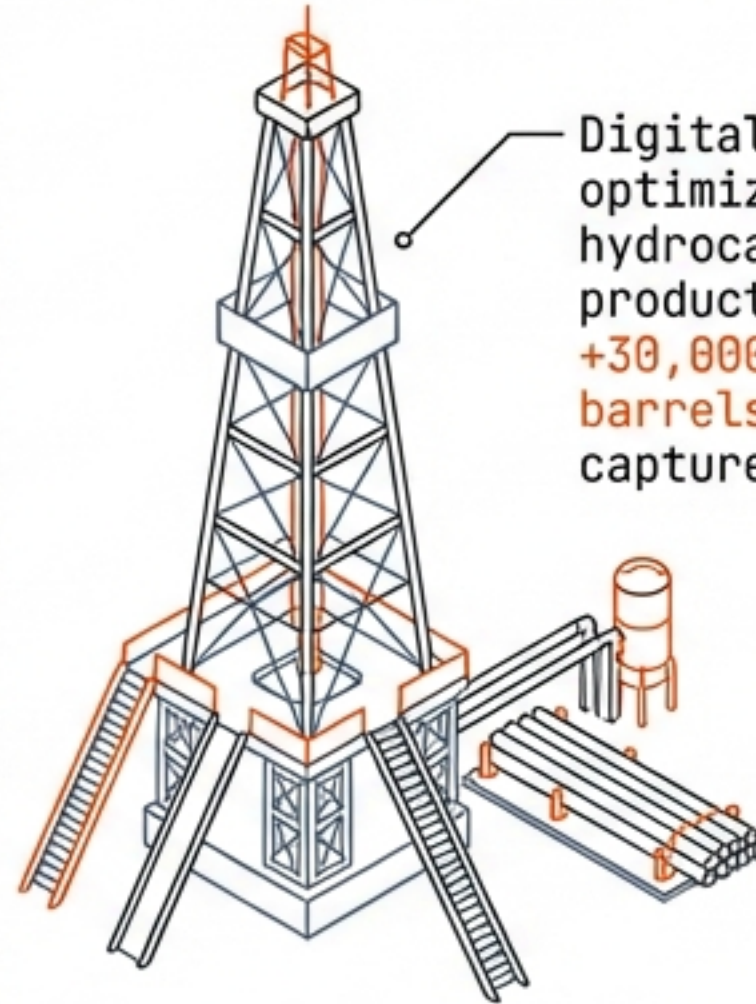

Digital Twin optimizes hydrocarbon production.
+30,000 barrels/daily captured.

TYSON FOODS

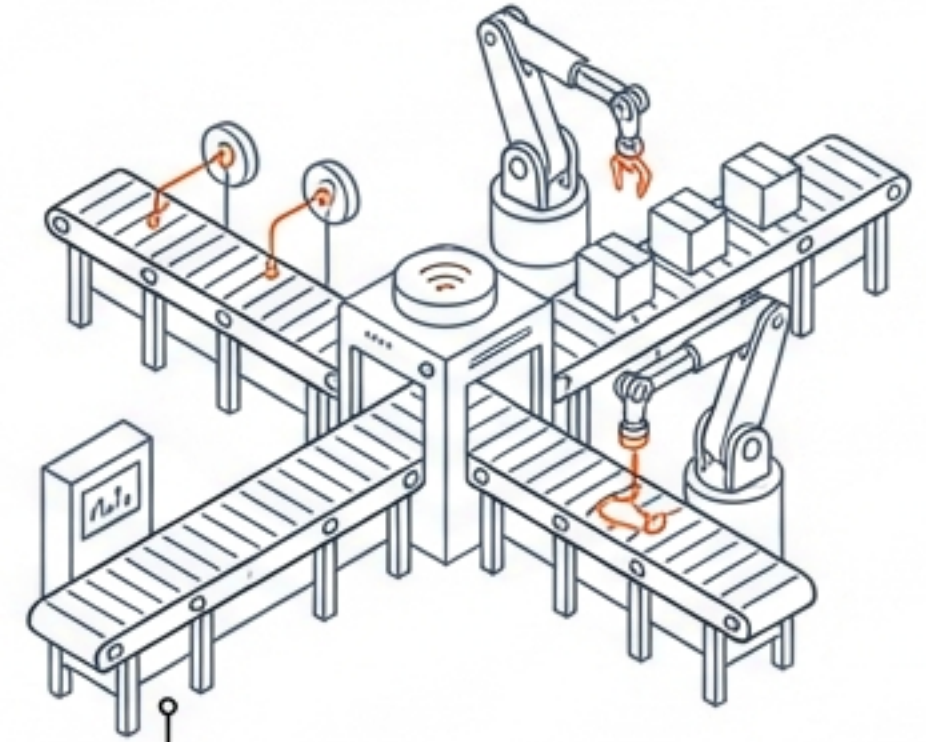

Digitized analog processes.
\$150M/year in savings.

ECOSYSTEM EXPANSION

SNOWFLAKE
Zero-copy interoperability

ORACLE
Cloud infrastructure alliance

FINANCIAL MASTERY: THE RULE OF 40



REVENUE GROWTH: +63%
(Q3 2025 YoY)

NET INCOME: \$476M
(12 Consecutive Quarters
of GAAP Profitability)

CASH ON HAND:
\$6.4 Billion

S&P 500 EFFECT:
Institutional Ownership
increased to **53%**.

THE ARCHITECTS: MISSION-ORIENTED MISFITS

ALEX KARP (CEO)

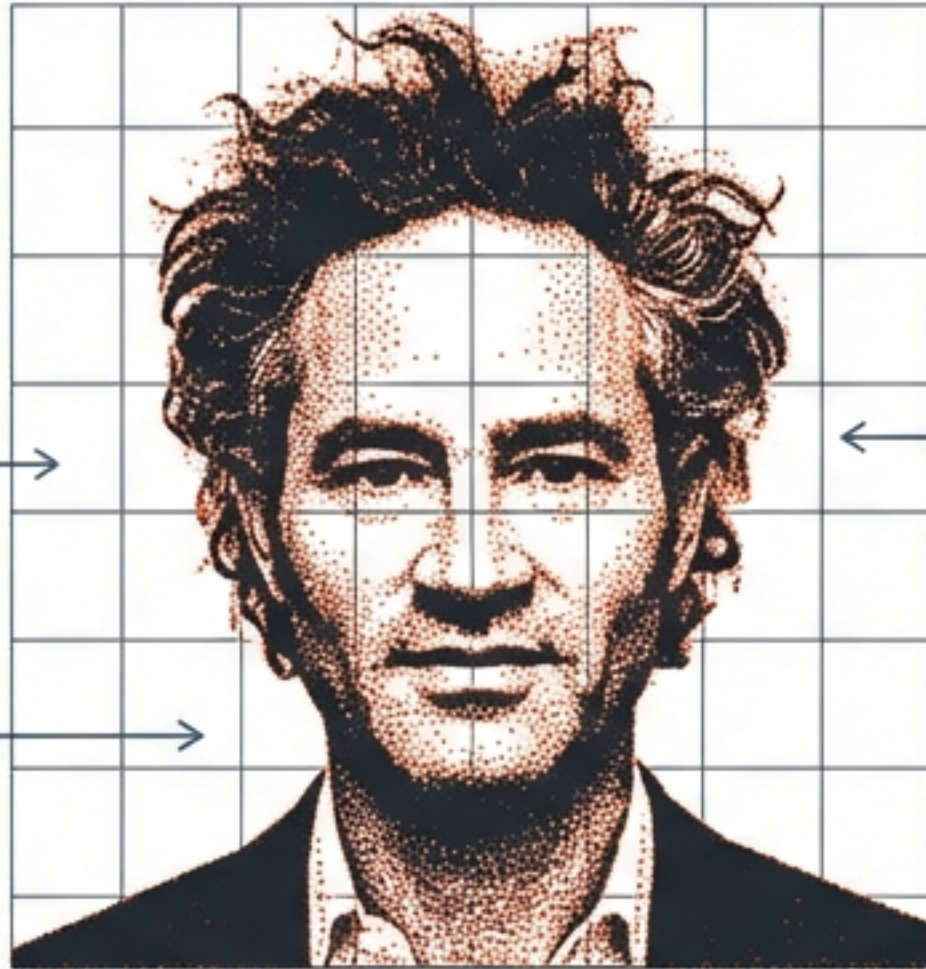

THE PHILOSOPHER-KING. PhD in Social Theory. Operates from New Hampshire backwoods. Philosophy: "The **Technological Republic**"—Software as the **defense of the West**.

SHYAM SANKAR (CTO)

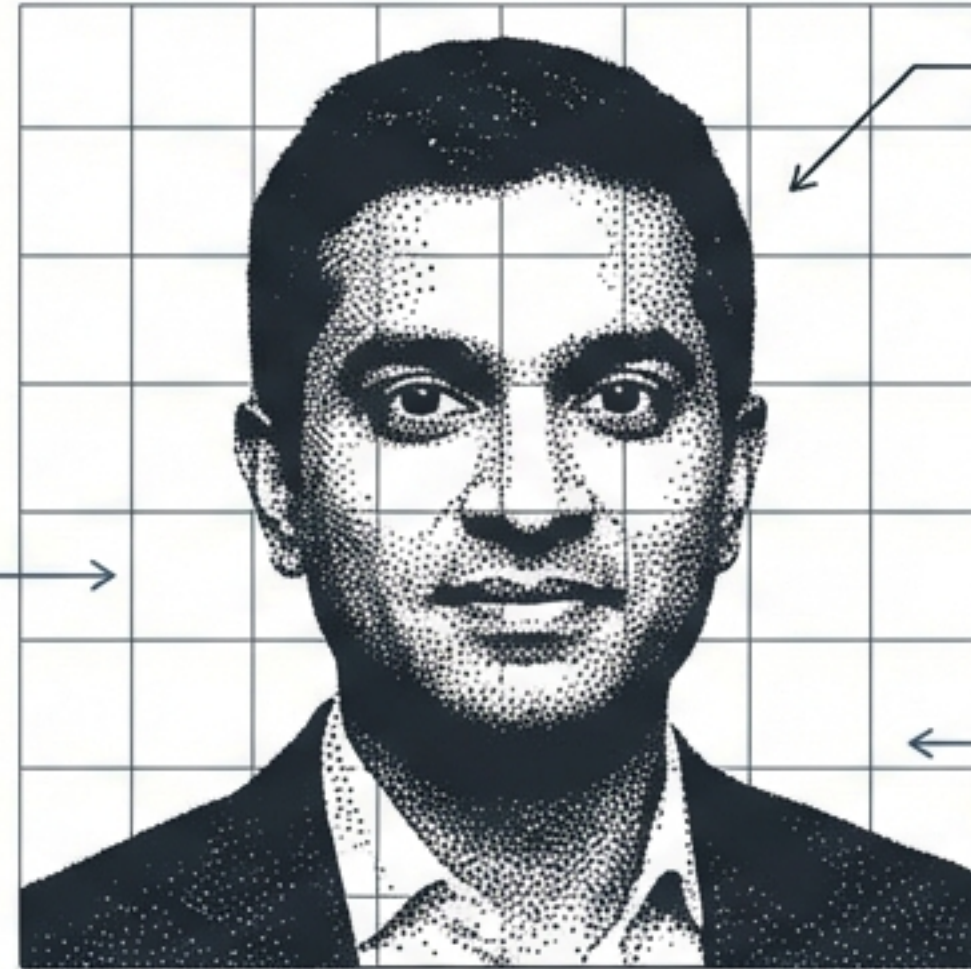

THE OPERATOR. **Employee #13.** Creator of the "Forward Deployed Engineer" model. Inducted into US Army Reserve innovation unit. **2025 Billionaire.**

PETER THIEL (CHAIRMAN)

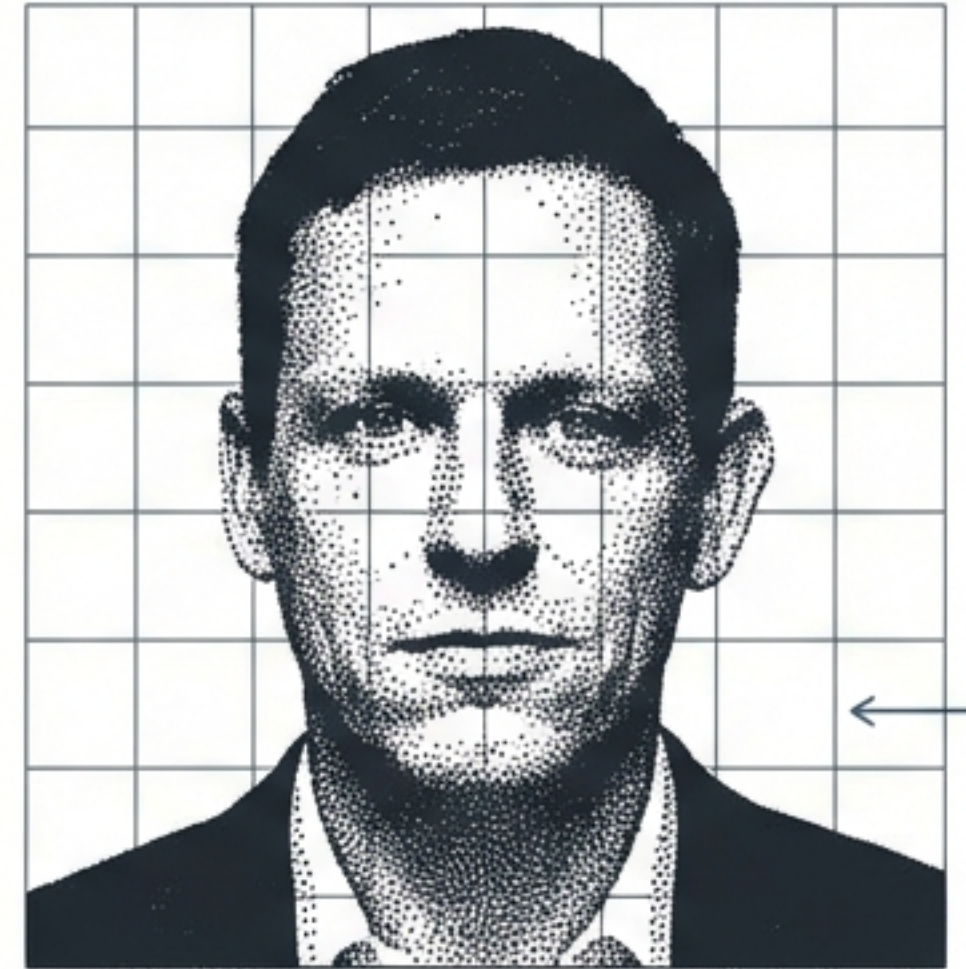

THE GODFATHER. Co-Founder. Provided the "**Zero to One**" monopoly philosophy and **Initial capital.**

THE SOVEREIGN DILEMMA: DIGITAL AUTONOMY

STRATEGY: SOVEREIGN AI

Selling nations independent operating stacks on their own infrastructure.

THE FRICTION (SWITZERLAND)

Rejected Palantir for 7 years. Concern: "US Access" / CIA backdoors / CLOUD Act.



THE ADOPTION (UK / NHS)

NHS "Federated Data Platform" (£330M Contract).

Prioritized operational efficiency over privacy protests.

The Global Choice: Build inferior domestic tools or adopt the Western Operating System.

REV	CONFIDENTIAL	
3.2	ENGINEERING DOCUMENT	
	1:1 SCALE	⊕ +

THE ETHICS OF HARD POWER: CONTROVERSY & RISK

SURVEILLANCE & POLICING

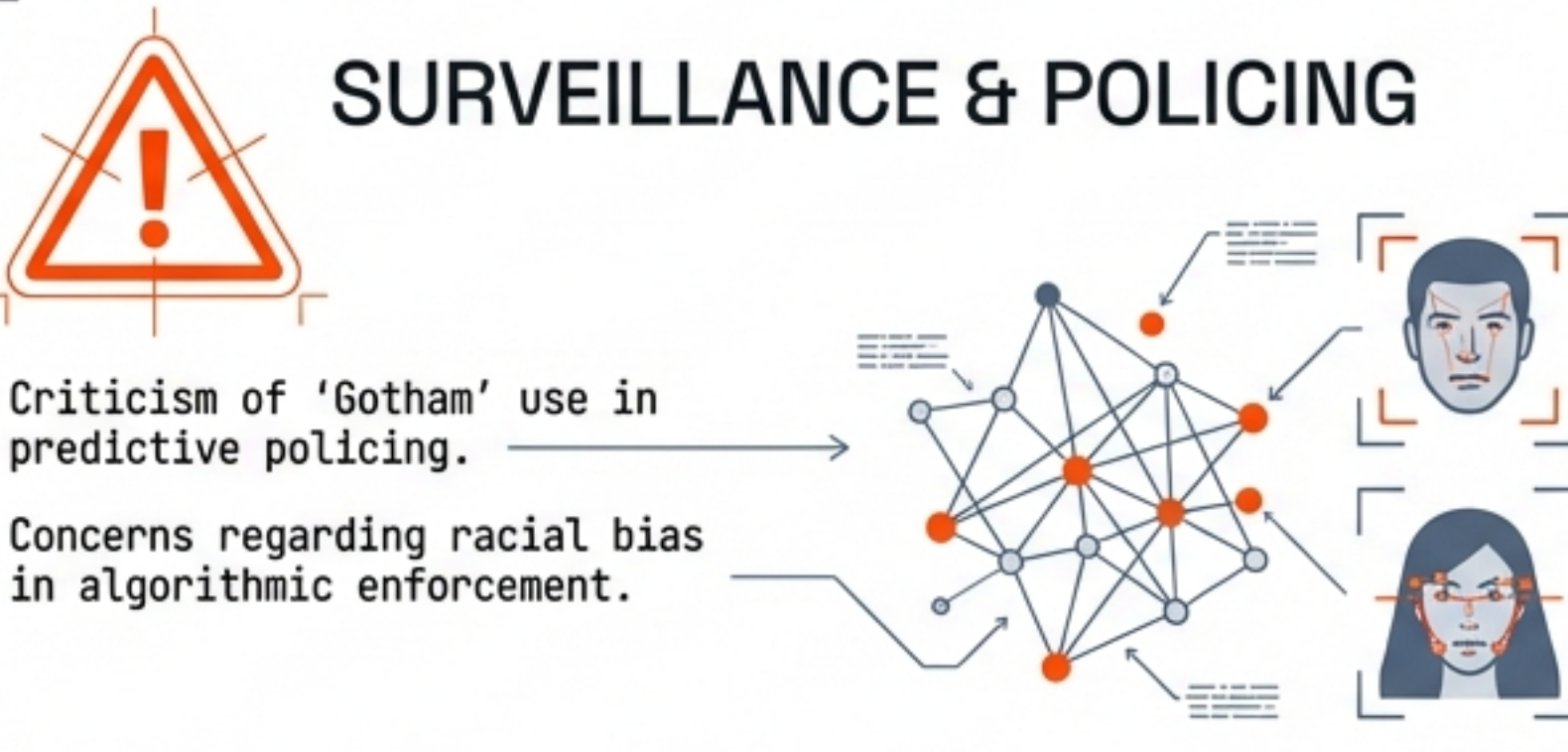

Criticism of 'Gotham' use in predictive policing.
Concerns regarding racial bias in algorithmic enforcement.

The diagram features a central neural network with nodes and connecting lines. To the right, two human faces are shown with red bounding boxes and facial recognition markers, indicating the application of AI in surveillance and policing.

IMMIGRATION ENFORCEMENT

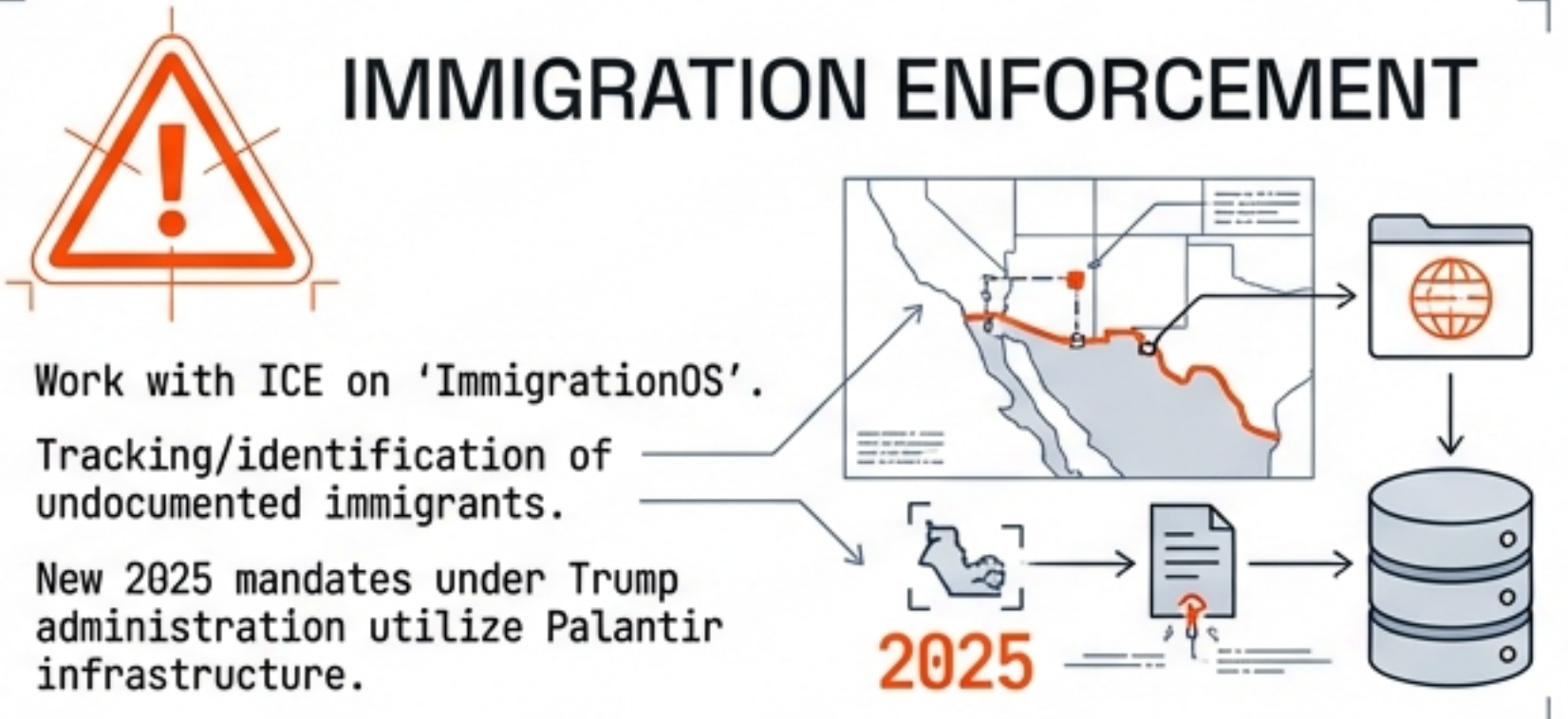

Work with ICE on 'ImmigrationOS'.
Tracking/identification of undocumented immigrants.
New 2025 mandates under Trump administration utilize Palantir infrastructure.

The diagram includes a map of the United States with a red line along the southern border. Below the map, there is a folder icon with a globe, a document icon with a red checkmark, and a database cylinder icon. The year '2025' is written in large orange text.

TECHNO-MILITARISM

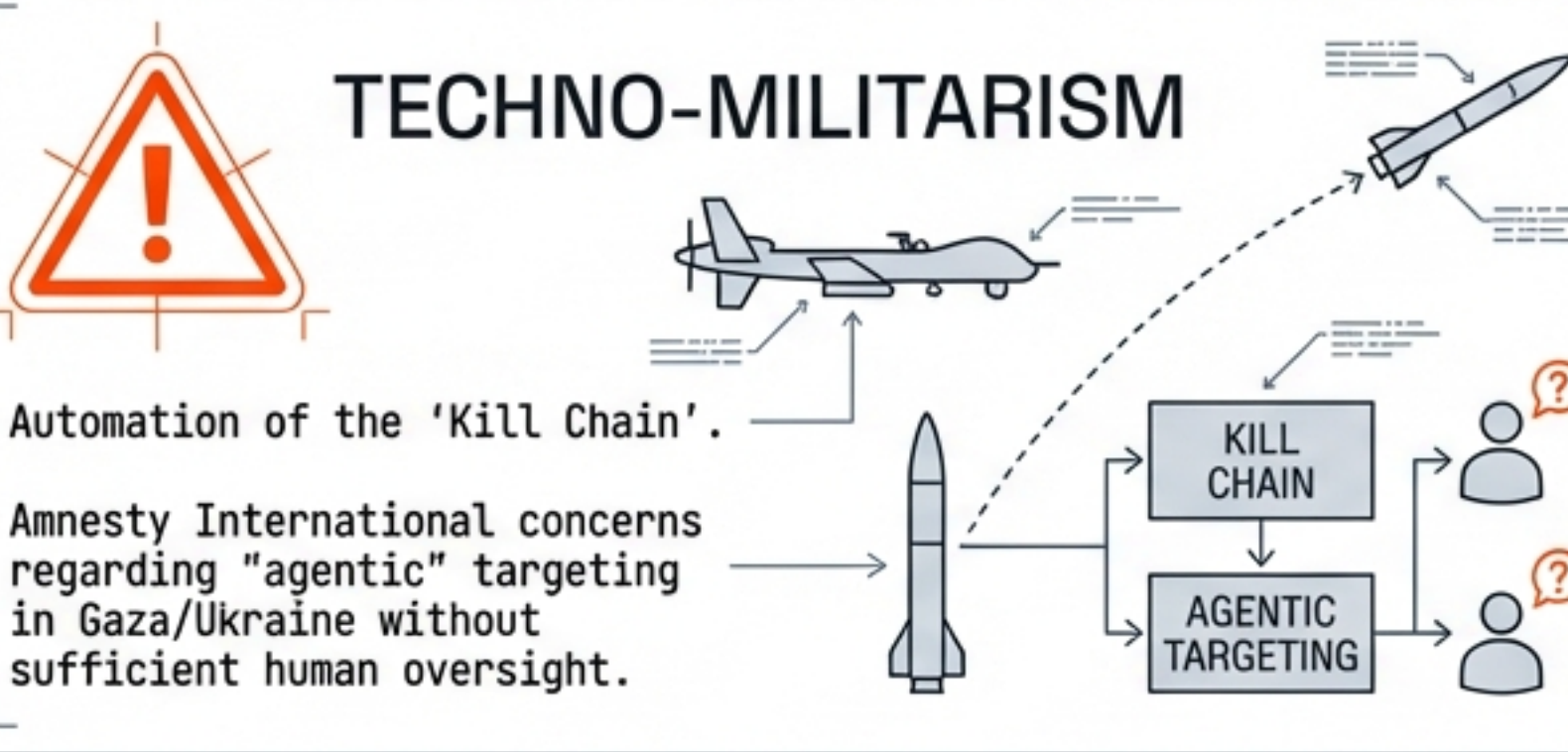

Automation of the 'Kill Chain'.
Amnesty International concerns regarding "agentic" targeting in Gaza/Ukraine without sufficient human oversight.

The diagram shows a jet aircraft and a missile. A dashed arrow points from the aircraft to the missile. Below, a flowchart shows a 'KILL CHAIN' leading to 'AGENTIC TARGETING', which then points to two human figures with question marks, representing the ethical concerns of autonomous targeting.

DATA PRIVACY

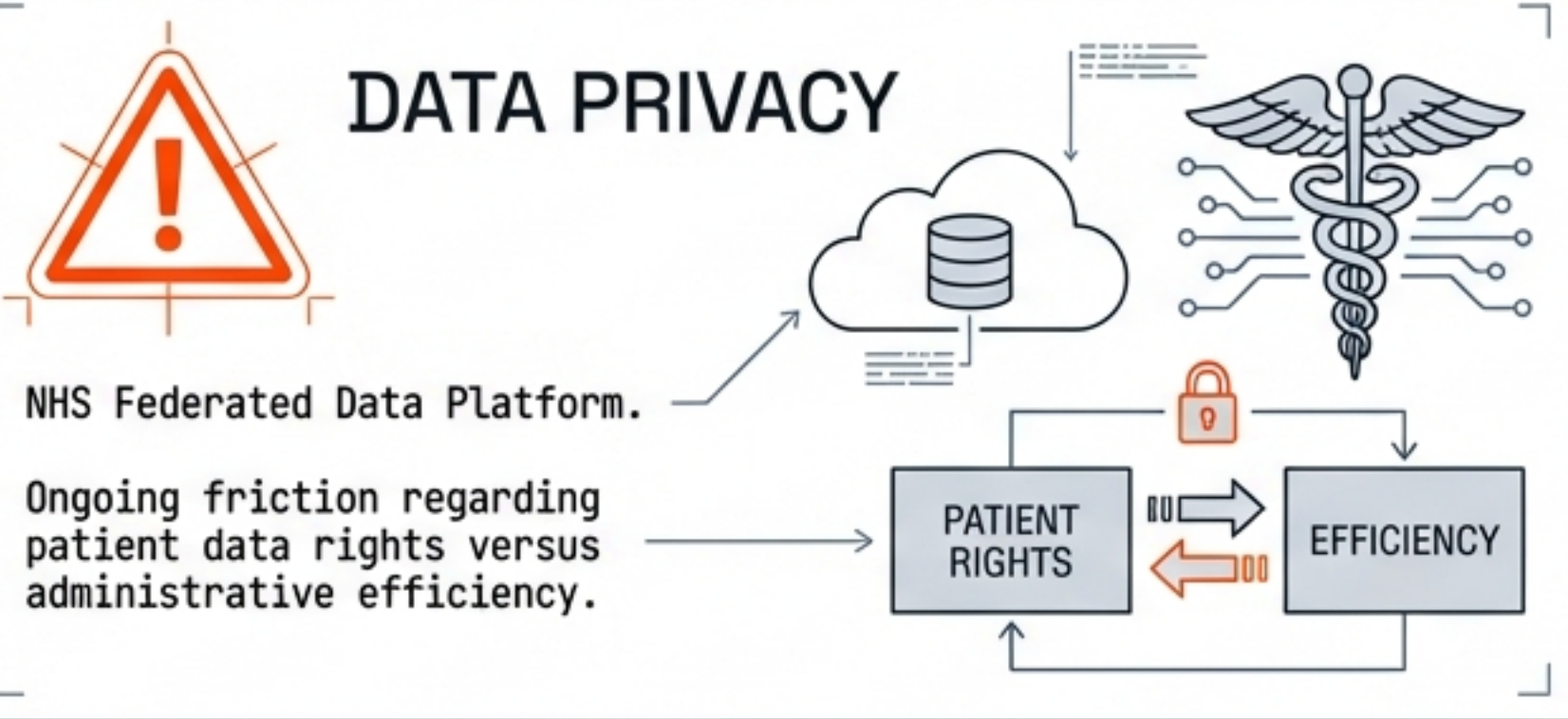

NHS Federated Data Platform.
Ongoing friction regarding patient data rights versus administrative efficiency.

The diagram features a cloud with a database icon, a caduceus symbol surrounded by circuit lines, and a diagram with two boxes labeled 'PATIENT RIGHTS' and 'EFFICIENCY'. A padlock icon is positioned between them, with arrows indicating a tension or friction between the two concepts.

THE HORIZON (2026): THE AGE OF AGENTIC AI



2023: THE CHATBOT

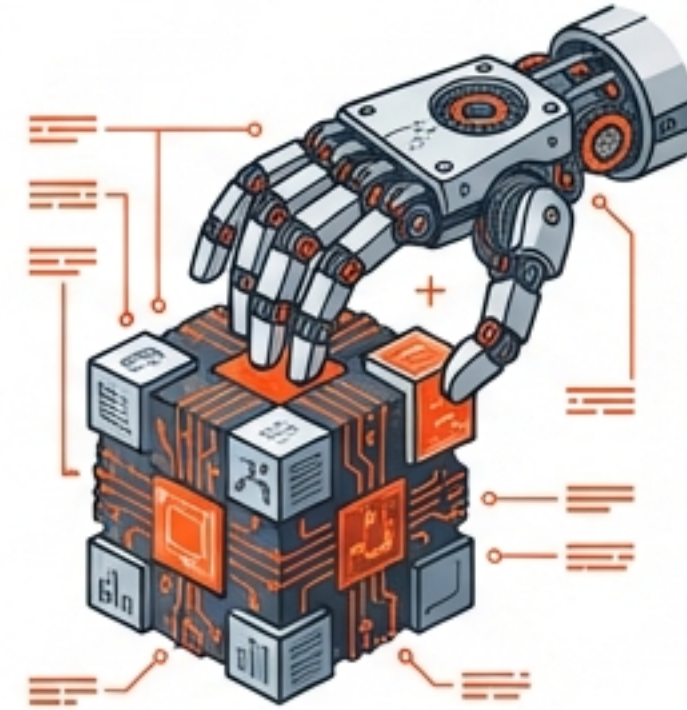

Text Generation.
"Write an email".



2026: THE AGENT

Action Execution.
"Re-route supply chain."
"Schedule maintenance."
"Order parts".

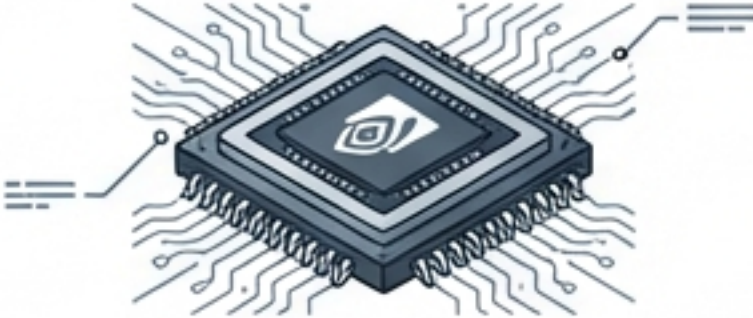
MARKET POSITIONING

HARDWARE	CLOUD	OPERATING SYSTEM
 <p>NVIDIA</p>	 <p>AZURE / AWS</p>	 <p>PALANTIR Capturing the Application Value Layer.</p>

CONCLUSION: THE ESSENTIAL INFRASTRUCTURE

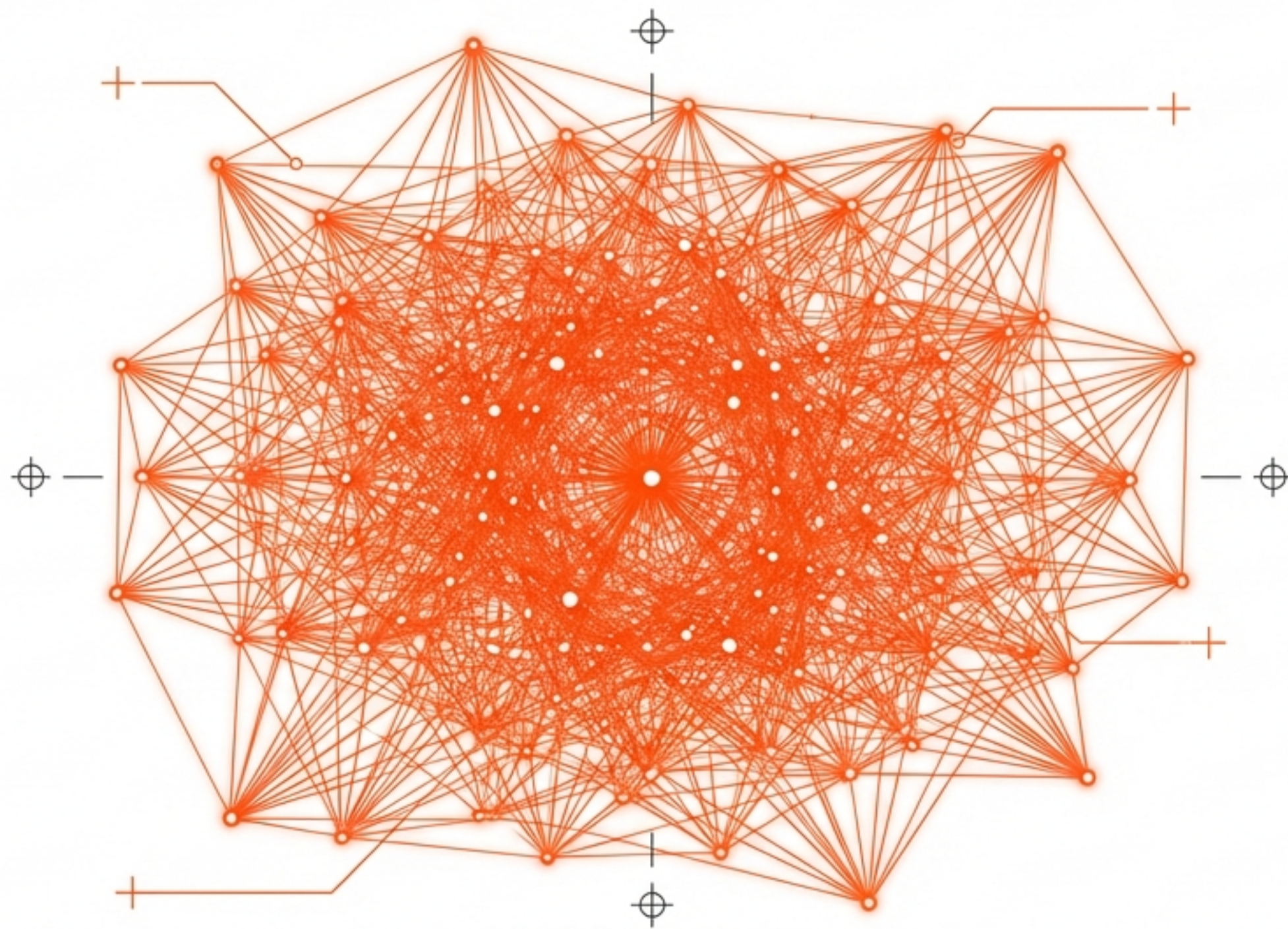

SOVEREIGN INTELLIGENCE

SUMMARY: Palantir has transcended "spy-tech" to become the Western Operating System. Unassailable moats in Defense (\$10B Army EA) and Enterprise (AIP).

INVESTMENT THESIS: A bet on Palantir is a bet on increasing geopolitical volatility and the necessity of operational AI.

FINAL THOUGHT: In a world of fragmenting supply chains and accelerating conflict, the organization with the best "Ontology" wins.

END OF ANALYSIS.